



Mr. Note Desk

Following the principles of the “rational design,” Mr. And Mrs. Note Desks embody timeless elegance.

Design to reflect the identity of the brand, where function creates attractive pureness, this product is an extension of the user, integrating custom work tools and storage.

Optional elements:

-Plain wooden top (without colored feature)



Technical Data

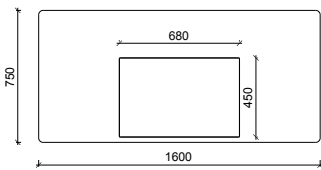

Optional Measurements:
1900x750x750mm

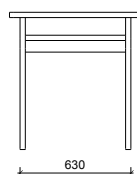
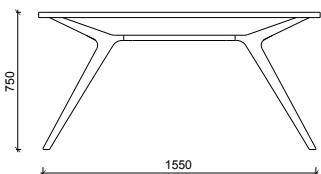

Box Size:
1700x850x950mm

Gross weight:
Aprox. 70kg

Volume:
1,38m³

Max. per Box
1 unit

Finishings

Main

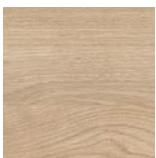

Plywood + Oak

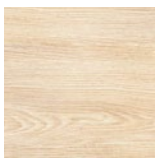

Oak

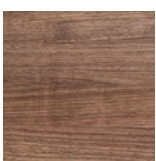

Walnut



Ebonized Oak

Linoleum

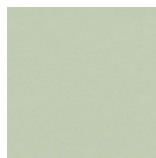

Pistachio



Salsa



Black

Faux Leather

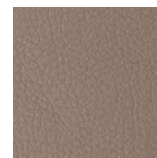

Taupe



Cement

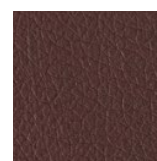

Light Brown



Mrs. Note Desk

Following the principles of the “rational design,” Mr. And Mrs. Note Desks embody timeless elegance.

Design to reflect the identity of the brand, where function creates attractive pureness, this product is an extension of the user, integrating custom work tools and storage.



Optional elements:
-Built-in power sockets
-Wireless charger

Technical Data

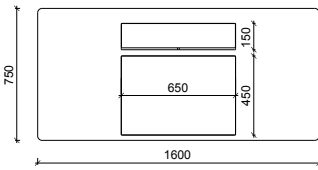

Optional Measurements:
1900x750x750mm

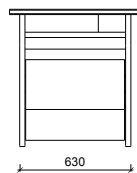
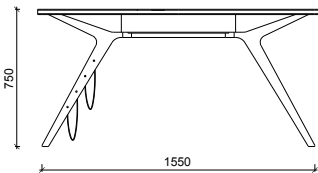

Box Size:
1700x850x950mm

Gross weight:
Aprox. 70kg

Volume:
1,38m³

Max. per Box
1 unit

Finishings

Main

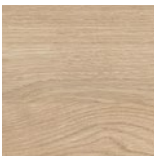

Plywood + Oak

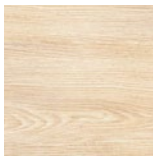

Oak

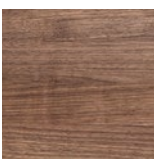

Walnut



Ebonized Oak

Faux Leather

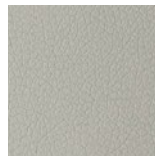

Cement

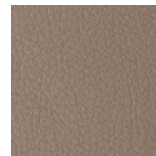

Taupe



Bordeaux

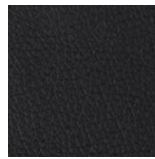

Black

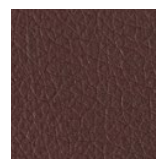

Light Brown

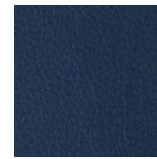

Blue



Butler Sideboard

A minimalist design, inspired by basic geometric shapes, free from any excess details. Thought to highlight the essence of materials, their textures, contrasts and let the user experience the elegance and its versatility in different spaces.



Note:
-Standard: 4 Doors and 2 hidden drawers.

Optional elements:
-Extra drawers.

Technical Data

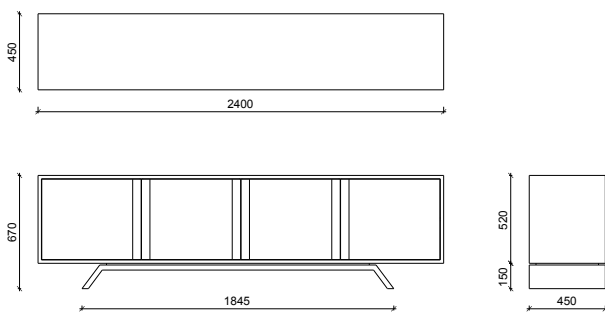

Optional Measurements:
2000x450x670mm

Box Size:
2500x550x820mm

Gross weight:
Aprox. 220kg

Volume:
1,13m³

Max. per Box
1 unit

Finishings

Main

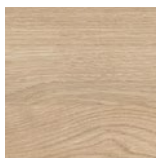

Oak

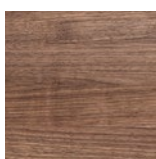

Walnut

Marble



Carrara



Nero Marquina

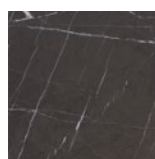

Grey Kendzo



William Lounge chair



William lounge is a chair with statement character, inspired by the classics of 20th century design. We bring our own interpretation of a classic archetype that will bring you a nostalgic feeling with contemporary language. Made with a high standard of quality and ergonomics where all non-essential elements were stripped off. The back leather stripes are more than just a reference, it's also to improve the seating smoothness.

Optional elements:

-Customer's own fabrics or leather.

Technical Data

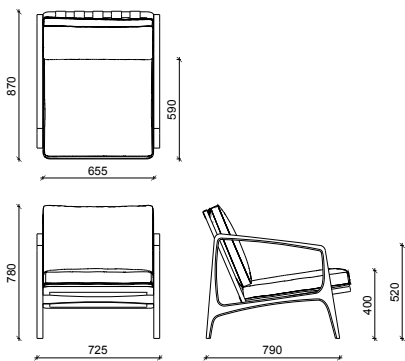

Optional Measurements:

N/A

Box Size:
800x950x950mm

Gross weight:
Aprox. 35kg

Volume:
0,73m³

Max. per Box
1 unit

Finishings

Main

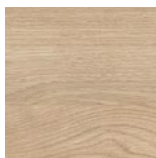

Oak



Ebonized Oak

Leather Stripes

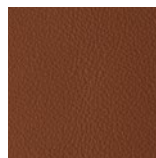

Cognac

Faux Leather

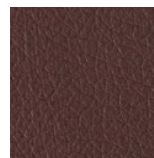

Light Brown

Fabric

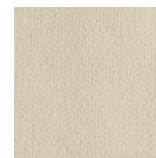

Pearl



Forest

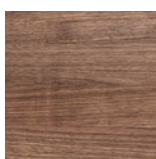

Walnut

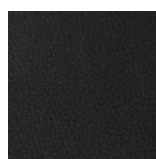

Black

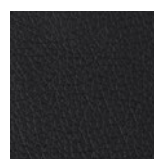

Black



Light Grey



Anthracite



Vault Sideboard

With its simplicity and clean shape this can take multiple functions as TV unit, Bookcase or sideboard, allowing to hide the storage or expose what its more utility, merging contemporary design with exquisite cabinet making.



Note:

-Standard: 4 Doors and 2 hidden drawers.

Optional elements:

-Built-in sound system.

-Led Stripe.

Technical Data

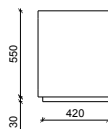
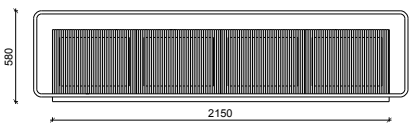
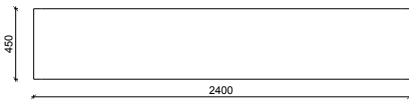

Optional Measurements:
2100x450x580mm

Box Size:
2500x550x700mm

Gross weight:
Aprox. 150kg

Volume:
0,96m³

Max. per Box
1 unit

Finishings

Main

Acoustic Fabric

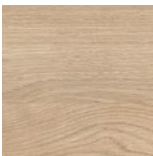

Oak

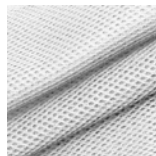

White

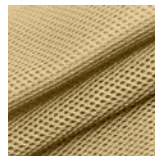

Khaki

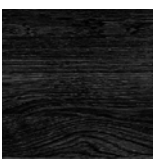

Ebonized Oak

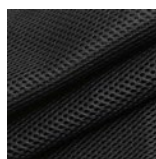

Black



Nokogiri coffee table

Following the principles of minimalist and multifunctional design, inspired by Japanese joinery and where woodworking joints are the key to produce this table. The addition of a cushion introduces it as an extra seat to the living area or as an entry bench in a process of continuous discovery between the user and the product.



Optional elements:
N/a

Technical Data

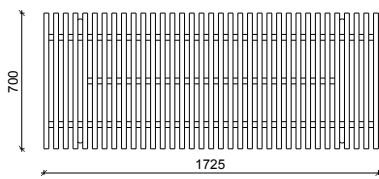

Optional Measurements:
1325x600x330mm

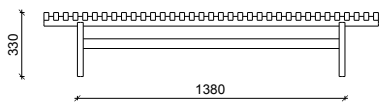

Box Size:
1800x800x480mm

Gross weight:
Aprox. 50kg

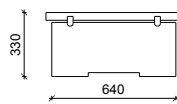

Volume:
0,70m³

Max. per Box
1 unit

Finishings

Main

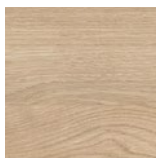

Oak

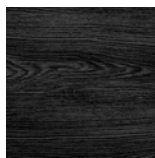

Ebonized Oak

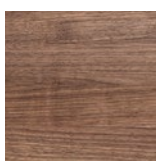

Walnut

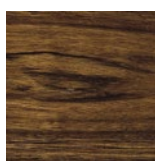

Mutene



Nokogiri bench | table

Following the principles of minimalist and multifunctional design, inspired by Japanese joinery and where woodworking joints are the key to produce this table. The addition of a cushion introduces it as an extra seat to the living area or as an entry bench in a process of continuous discovery between the user and the product.



Optional elements:
-Cushion.
-Marble tray

Technical Data

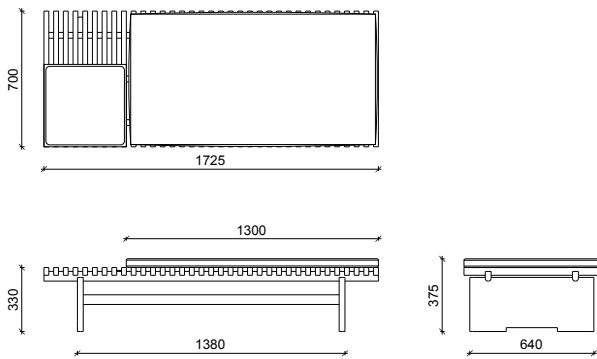

Optional Measurements:
1325x600x375mm

Box Size:
1800x800x480mm

Gross weight:
Aprox. 55kg

Volume:
0,70m³

Max. per Box
1 unit

Finishings

Main

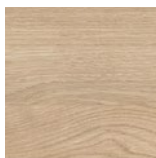

Oak

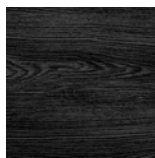

Ebonyed Oak

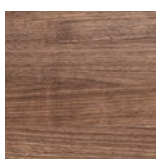

Walnut

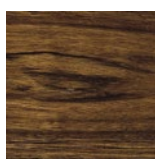

Mutene

Fabrics

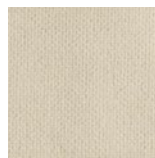

Pearl

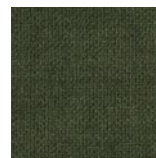

Forest



Light Grey



Anthracite

Marble



Carrara



Nero Marquina

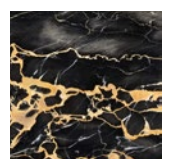

Portoro



Stellar coffee table

A futuristic based coffee table that explores the sensation of the different textures, metal, wood and marble, exploring circular shapes and intercepting them at different levels.



Optional elements:
N/a

Technical Data

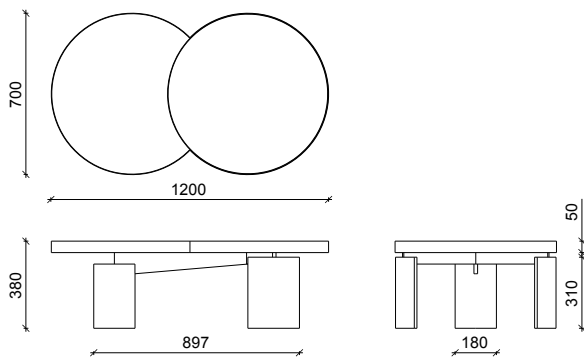

Optional Measurements:
N/a

Box Size:
1300x800x520mm

Gross weight:
Aprox. 30kg

Volume:
0,54m³

Max. per Box
1 unit

Finishings

Main

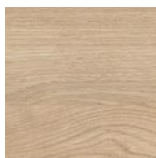

Oak

Marble



Carrara

Metal

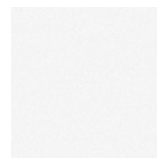

White

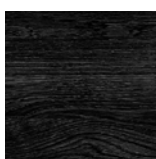

Ebonized Oak

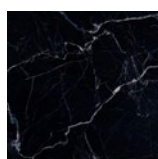

Nero Marquina

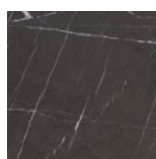

Grey Kendzo

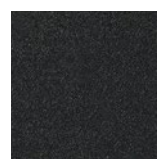

Black



Dona Table

Starting from the archetype of "table", a familiar concept that we share in our collective memory. In a sense of continuity and evolution, this table adapts to every daily situation in a new home landscape where the leisure co-exists with work. A colored centre board can be decorative or an optional extendable platform to better accommodate your family meetings.



Optional elements:
-Bespoke color
-Extendable version.

Technical Data

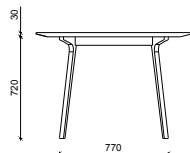
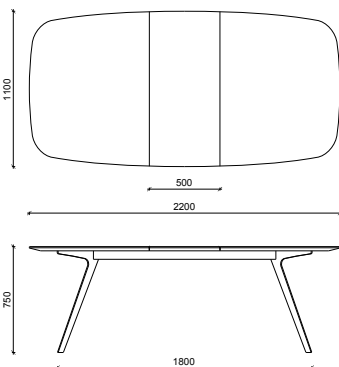

Optional Measurements:
2000x1000x750mm
2500x1100x750mm
2000-(2600)x1100x750mm (Extendable)

Box Size:
2300x1200x900mm

Gross weight:
Aprox. 70kg

Volume:
2,48m³

Max. per Box
1 unit

Finishings

Main

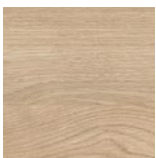

Oak



Ebonized Oak

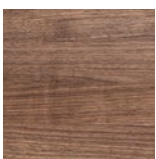

Walnut

Color

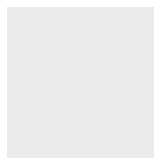

White



Black

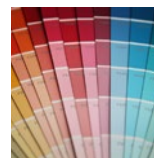

Bespoke:
Ral or pantone.



Old Fashioned Sideboard

Like the famous drink, this sideboard resembles a product shape that it's well known of us. So as the concept, this clean lines product was thought to last, from the design that allows its own discreet presence, to eye-catching details. The bar area is highlighted by a distinct color as so the wooden stripes. The metal inlays on base show how a structure can be involved in aesthetics.



Optional elements:
-Bespoke color.

Technical Data



Optional Measurements:
-2400x450x800mm

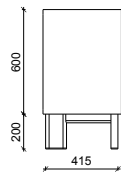
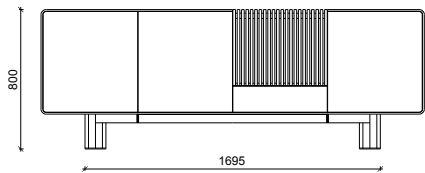

Box Size:
2300x550x920mm

Gross weight:
Aprox.200kg

Volume:
1,17m³

Max. per Box
1 unit

Finishings

Main

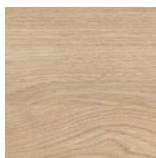

Oak



Ebonized Oak

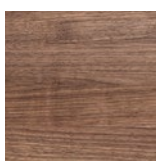

Walnut

Color

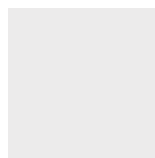

White



Black



Bespoke:
Ral or pantone.



Slither Tv unit

This distinctive piece brings character and new energy into the living area. Masterfully crafted with curved frame and legs, this tv unit was thought to adapt and to last. The Sliding door allows the user to hide electronic equipments still being able to use them, but also allows to choose what side to be closed.

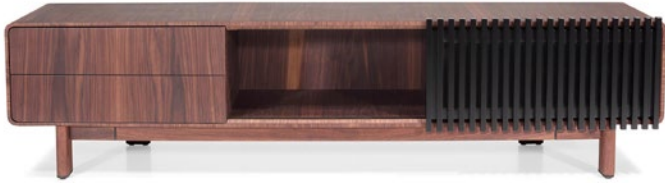

Optional elements:
N/a

Technical Data

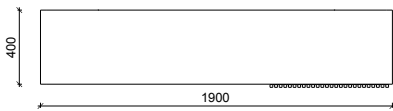

Optional Measurements:
2200x400x450mm

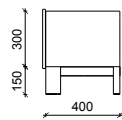
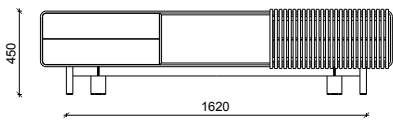

Box Size:
2000x500x600mm

Gross weight:
Aprox. 70kg

Volume:
0,6m³

Max. per Box
1 unit

Finishings

Main

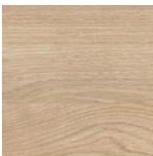

Oak



Ebonized Oak

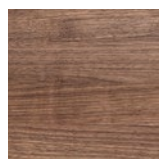

Walnut

Color

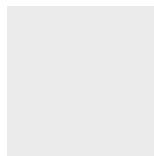

White



Black

Acoustic Fabric

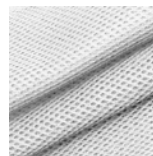

White

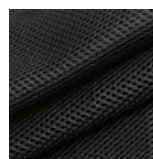

Black



HT Shelving 1



A modular bookshelf with an exciting design and versatility. For a custom touch, endless options are available by combining colours, shelves typology, storage and strategically placing shelves at different heights. Whether used to display accessories or accommodate books and other objects, can be used in the living area, dining, lounge or in the office.

Note:
Must be fixed to the wall.

Optional elements:
- Replace storage unit by shelves

Technical Data

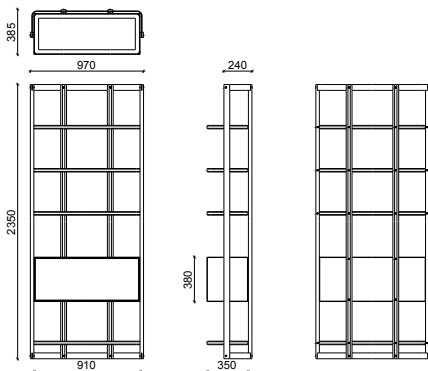

Optional Measurements:
N/a

Box Size:
2400x150x150
1000x700x500

Volume
0,06m³
0,36m³

Qt. of volumes:
2

Gross weight:
75kg

Finishings

Main

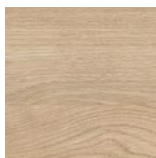

Oak

Metal

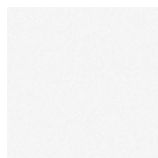

White

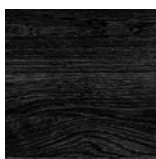

Ebonized Oak

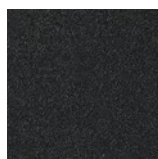

Black



HT Shelving 2



A modular bookshelf with an exciting design and versatility. For a custom touch, endless options are available by combining colours, shelves typology, storage and strategically placing shelves at different heights. Whether used to display accessories or accommodate books and other objects, can be used in the living area, dining, lounge or in the office.

Note:
Must be fixed to the wall.

Optional elements:
-Additional storage module with folding door.

Technical Data

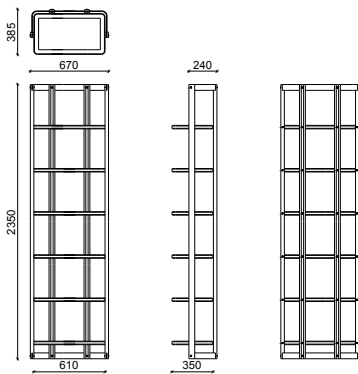

Optional Measurements:
N/a

Box Size:
2400x150x150
700x700x500

Volume
0,06m³
0,25m³

Qt. of volumes:
2

Gross weight:
65kg

Finishings

Main

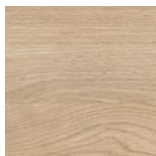

Oak

Metal

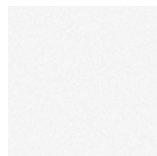

White

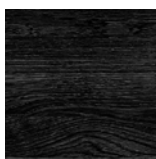

Ebonized Oak

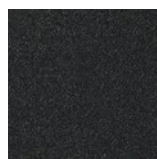

Black